

## 3" CHEMFLY™ LIGHT

Series LY 3" Butterfly valve

The Perolo CHEMFLY LIGHT™ 3" butterfly valve is designed to discharge liquid chemicals and foodstuffs carried in road tankers, rail tank cars or stored in static tanks.

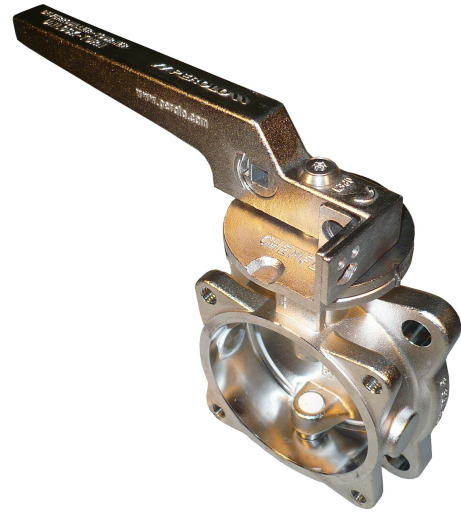

### Specifications

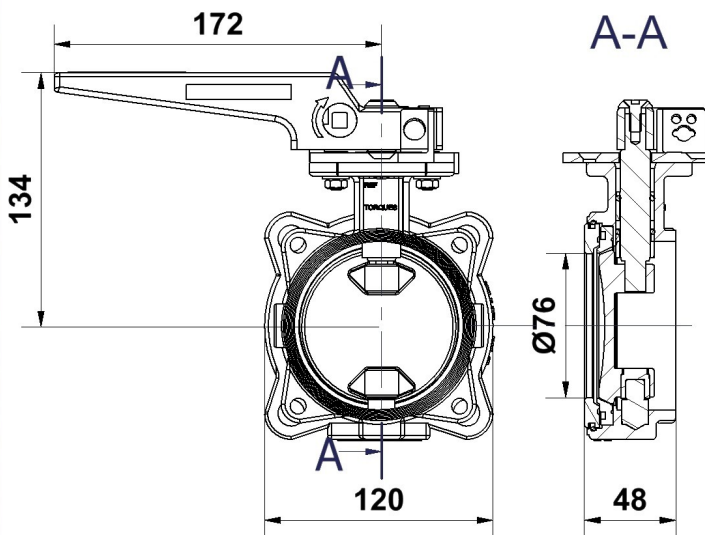

- Nominal diameter : 3" (76mm)
- Weight : 2.8 kg.
- Container flange : 4x14xPCD130mm
- Outlet : 4xM10xPCD120mm
- MAWP : 6 Bar
- Test pressure : 9 Bar
- Design temperature : -40°C/190°C

### Features

- 316L/1.4404 Stainless Steel
- Compact design (face to face 48mm)
- FEP/PTFE seals
- ¼ turn operation
- Easy maintenance and cleaning
- Locking handle

### Options

- Other tank side drilling
- Venting ports 3/8" BSP or 3/8" NPT or 1/2" BSP

### Approval & Certifications

- Comply with ADR 2009
- Approved by Bureau Veritas.
- Comply with EN 14432.

### Accessories

- 3" CHEMFLY™ butterfly valve. Part#LY311H.
- 3" CHEMFLY™ bottom discharge. Part#VLY311H1111.
- 3" BSP Short Outlet . Part#17 12 09 70 00.
- 3" BSP Long Outlet . Part#17 12 09 71 00.

Bottom Discharge

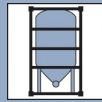
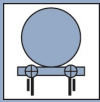

## Codification

1. Base code of your 3" CHEMFLY™

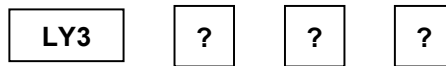

2. Inlet flange drilling

- 4x14xPCD130mm

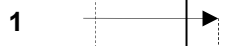

3. Outlet flange drilling

- 4xM10xPCD120mm



4. Venting ports

- None
- 1x 3/8" NPT
- 1x 3/8" BSP
- 2x 3/8" NPT
- 2x 3/8" BSP
- 1 x 1/2" BSP

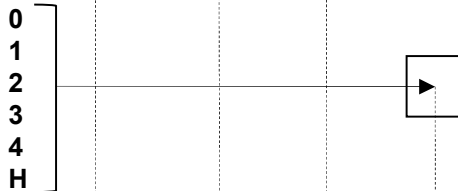

Final code of your 3" CHEMFLY™  
Bottom discharge

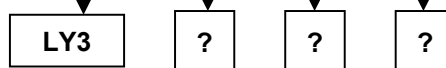

**STANDARD PART#**



Bottom Discharge