

## 2" TANKFLY™ Flanged

Series TF4X butterfly valves

The 2" TANKFLY™ flanged butterfly valve is designed to be used as an air inlet/outlet valve.

Made of 316L/1.4404 stainless steel, the TANKFLY™ valve is applicable to tank containers, rail tanks, road tankers and static tanks dedicated to transporting or storing chemicals and liquid foodstuff.



### Specifications

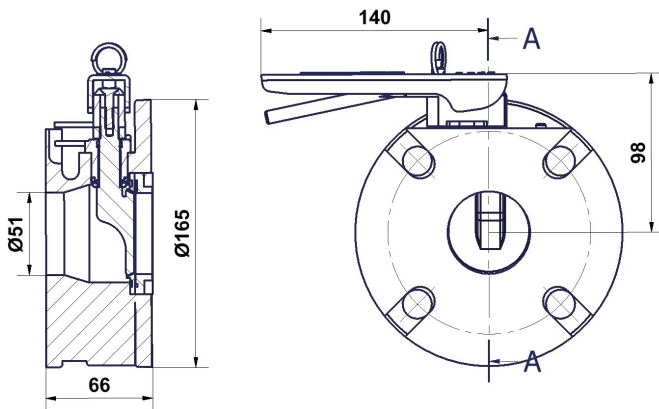

- Nominal diameter: 51mm (2")
- Maximum weight : 4 kg
- Container side flange: 4 x Ø18 on a Ø125PCD
- Outlet side flange : 4 x slots 18 on a min Ø114PCD
- MAWP : 4 bar
- Test pressure : 6 bar
- Design Temperature : 190°C
- Working Temperature : -40°C +150°C

### Approval & Certifications

- Comply with IMDG & ADR
- Comply with EN14432
- Approved by Bureau Veritas

### Features

- Full 316L/1.4404 stainless steel construction
- Compact design. Face to face : 66mm
- ¼ turn operation
- Easy filter change
- FEP/PTFE seals
- Pressure gauge connection

### Options

- Extreme resistance to corrosion with :
  - HALAR coating body
  - Closure plate & closure seal in Hastelloy C276
- Over pressure valve connection
- Sintered disc
- Gauge protection

### Accessories

- |                                     |                     |
|-------------------------------------|---------------------|
| • Filter.                           | Part#11 12 03 94 00 |
| • Weld in flange.                   | Part#11 90 25 00 00 |
| • Recess flange.                    | Part#11 92 44 00 00 |
| • Bolting kit.                      | Part#11 91 13 91 00 |
| • Gasket.                           | Part#11 90 29 00 00 |
| • Blind flange.                     | Part#17 12 12 16 01 |
| • Tool kit for sleeve installation. | Part#11 12 03 98 00 |

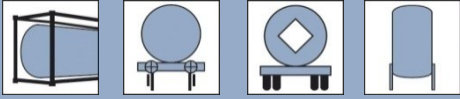

## 2" TANKFLY™ Flanged Series TF4X butterfly valves

Air Inlet

### Codification

1. Base code of your TANKFLY 2" Flanged BSP Butterfly valve

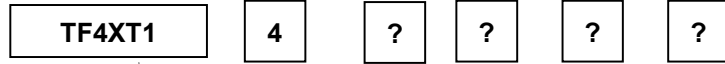

2. Outlet connections  
- 4xslots 18 x PCD114  
ISO 9669 compatible ANSI 150  
& matching with 2" BSTE

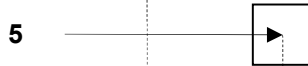

3. Gauze protection  
-Sintered disc  
-With gauze  
-Without gauze

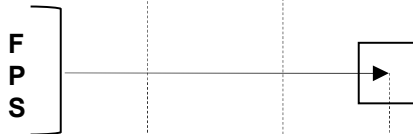

4. Plug  
- BSP 1/4"  
- NPT 1/4"  
-Without

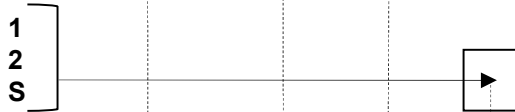

5. Gauge protection  
- Without  
- With Gauge protection

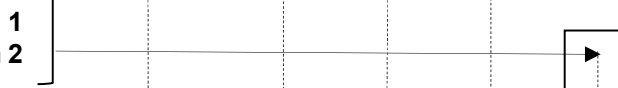

6. Over pressure valve connection  
- Without  
- With

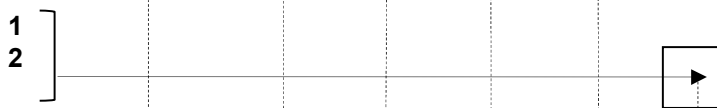

Final code of your 2" TANKFLY Flanged Butterfly valve

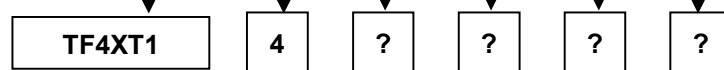

**STANDARD PART#**



For any specific requests, please feel free to contact our sales department at [sales@perolo.com](mailto:sales@perolo.com)

